

G型螺纹配管用卡套式接头 (选购件)

平行管螺纹阴接头

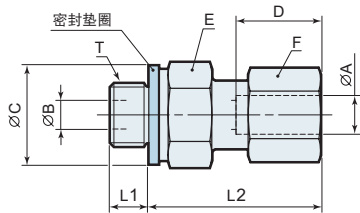
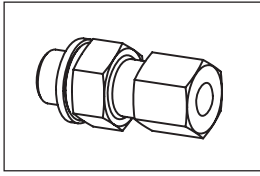

(mm)

型号	管外径 φA	T	B	C	D	六角对边宽		L1	L2
						E	F		
8FKCO06010	6	G1/8	4	17	17.5	14	14	6	32.5
8FKCO08010	8		4	17	17.5	17	17	6	32.5
8FKCO08020	8	G1/4	6	20.5	17.5	19	17	10	33.5
8FKCO10020	10		6	20.5	18.5	19	19	10	34.5
8FKCO10030	10	G3/8	8	24	18.5	22	19	10	35.5
8FKCO12030	12		8	24	18.5	22	22	10	35.5

平行管螺纹阳接头

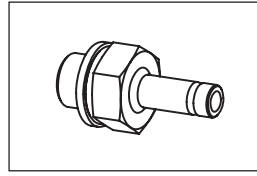

另一侧请使用Ihara Science公司的NE型钢管用卡套式接头。

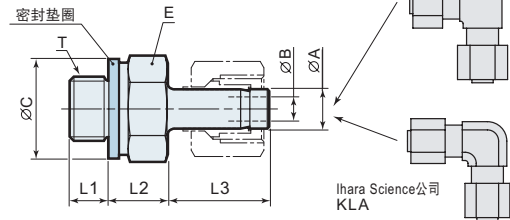

(mm)

型号	管外径 φA	T	B	C	六角对边宽 E	L1	L2	L3
8FKHB08020	8	G1/4	5	20.5	19	10	10	21
8FKHB10020	10		6	20.5	19	10	10	22
8FKHB10030	10	G3/8	6	24	22	10	11	22
8FKHB12030	12		8	24	22	10	11.5	22.5

双头螺纹弯管接头

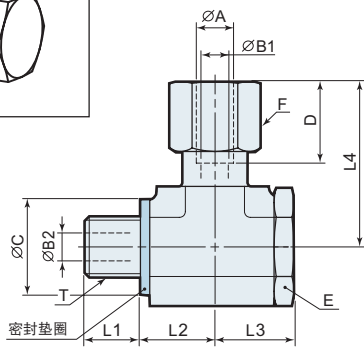
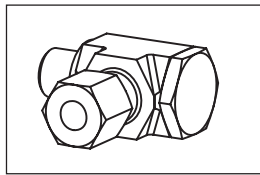

(mm)

型号	管外径 φA	T	B1	B2	C	D	六角对边宽		L1	L2	L3	L4
							E	F				
8FKMB06010	6	G1/8	4	4	17	17.5	17	14	8	13	14	33.5
8FKMB08020	8	G1/4	6	7	20.5	17.5	22	17	12	16	17	35.5
8FKMB10020	10		8	7	20.5	18.5	22	19	12	16	17	36.5
8FKMB12030	12	G3/8	10	9	24	18.5	27	22	12	19	22	40.5

密封垫圈

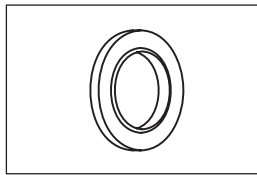

橡胶材料以NBR、金属环以SPCC(冷轧钢板)为标准规格。

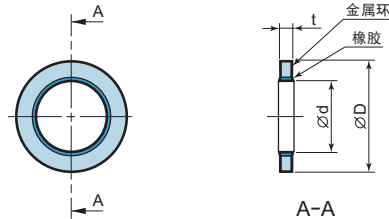

(mm)

型号	螺纹	d	D	t
8FKP-C-010	G1/8	9.9	17	2
8FKP-C-020	G1/4	13.3	20.5	2
8FKP-C-030	G3/8	16.8	24	2

- 1: 使用G型螺纹配管用卡套式接头时, 请务必用附带的堵头堵住座垫配管用油压接口。
- 2: 接头安装面座面请使用密封垫圈。(请不要使用O环形式的G型螺纹接头)
- 3: 请使用Ihara Science公司的套筒(KKO)